

FIGURE 1

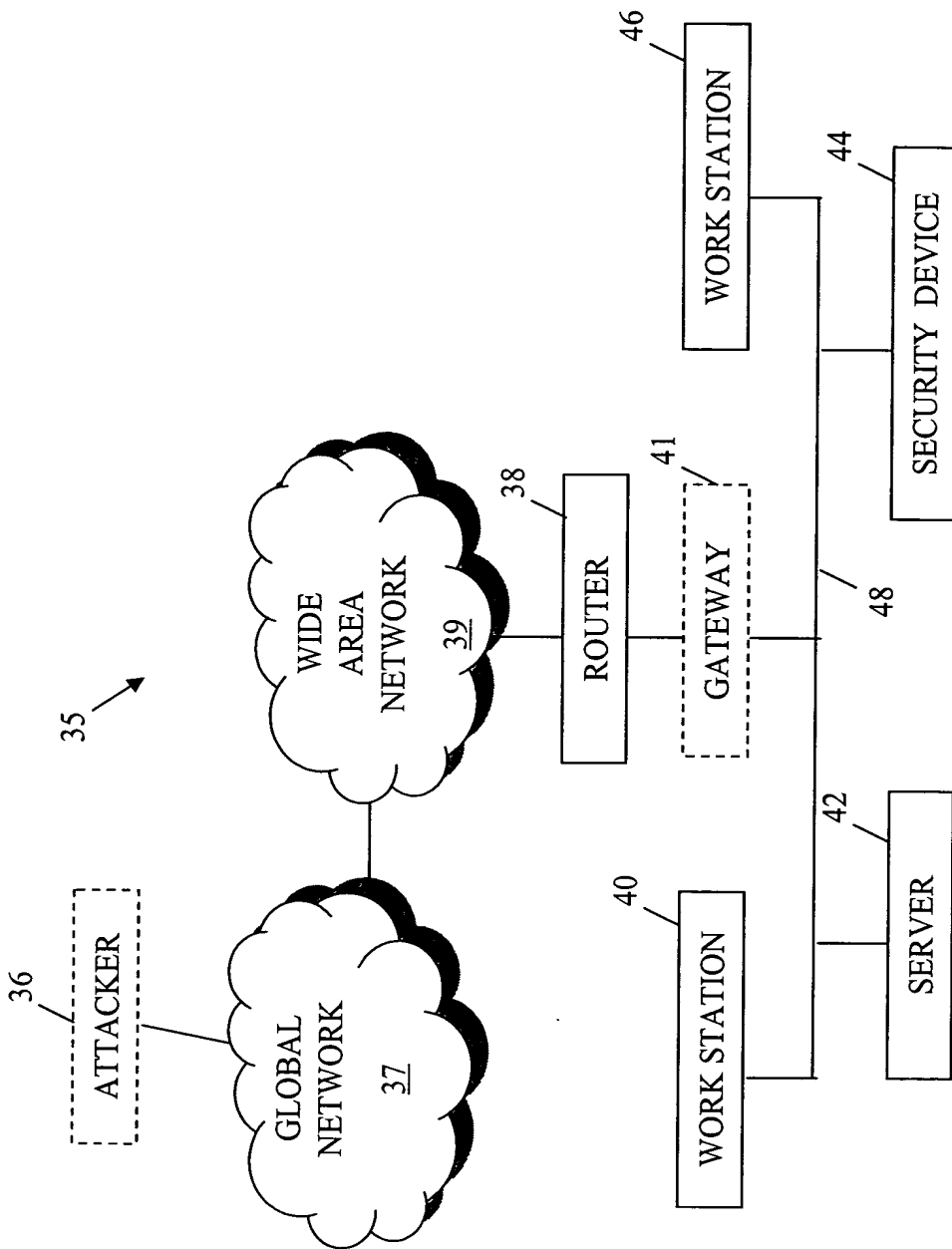

FIGURE 2

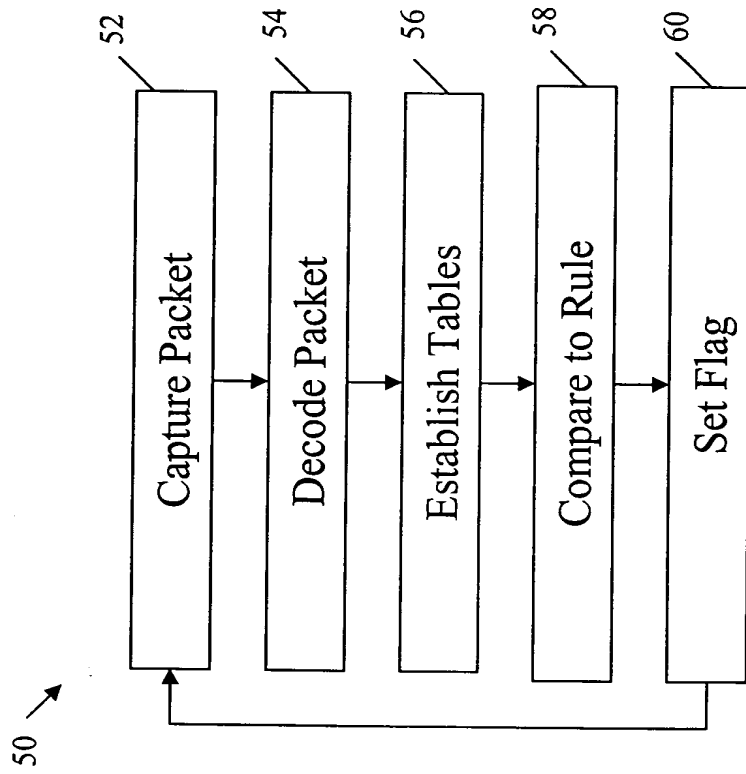

FIGURE 3

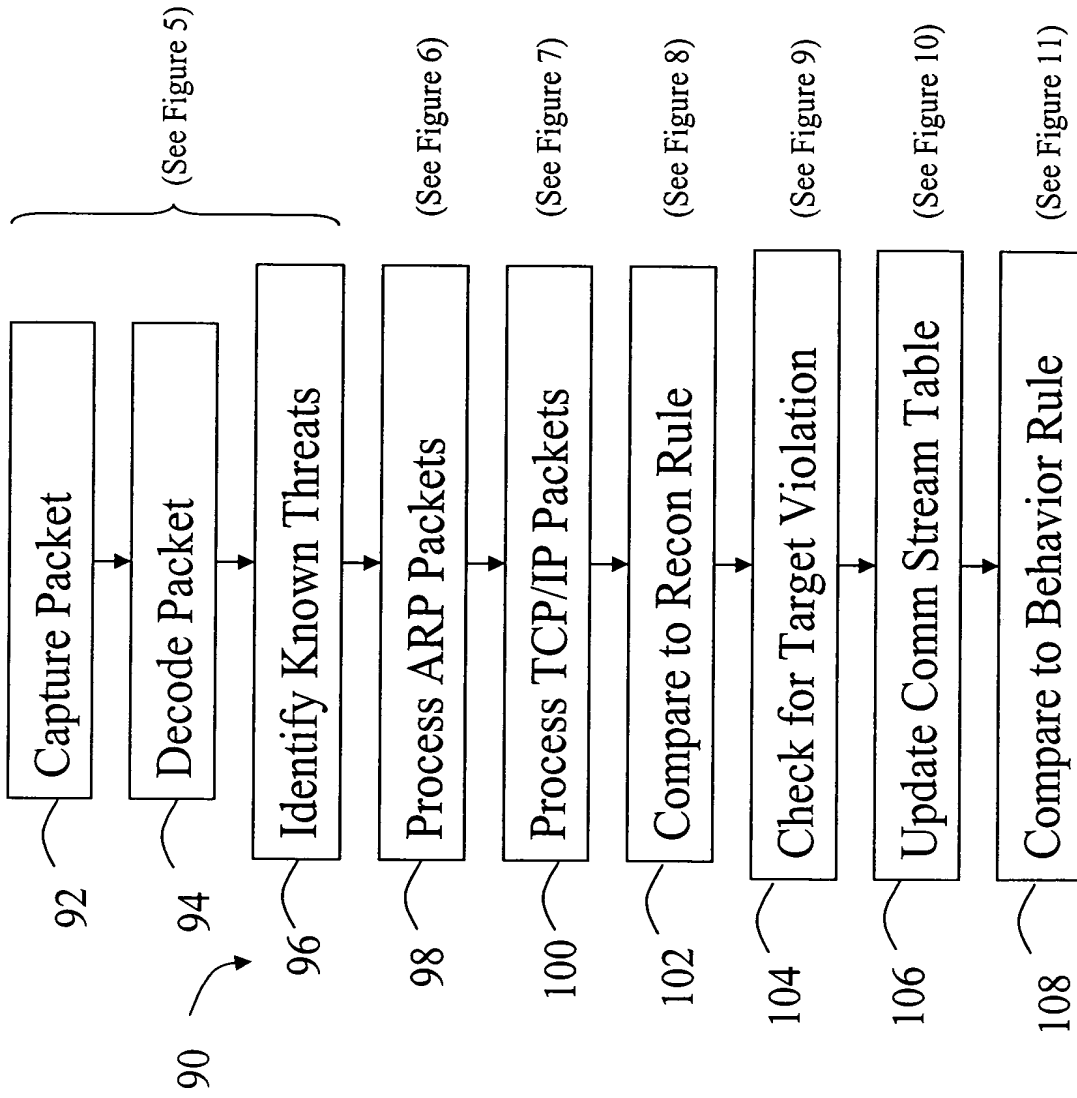

FIGURE 4

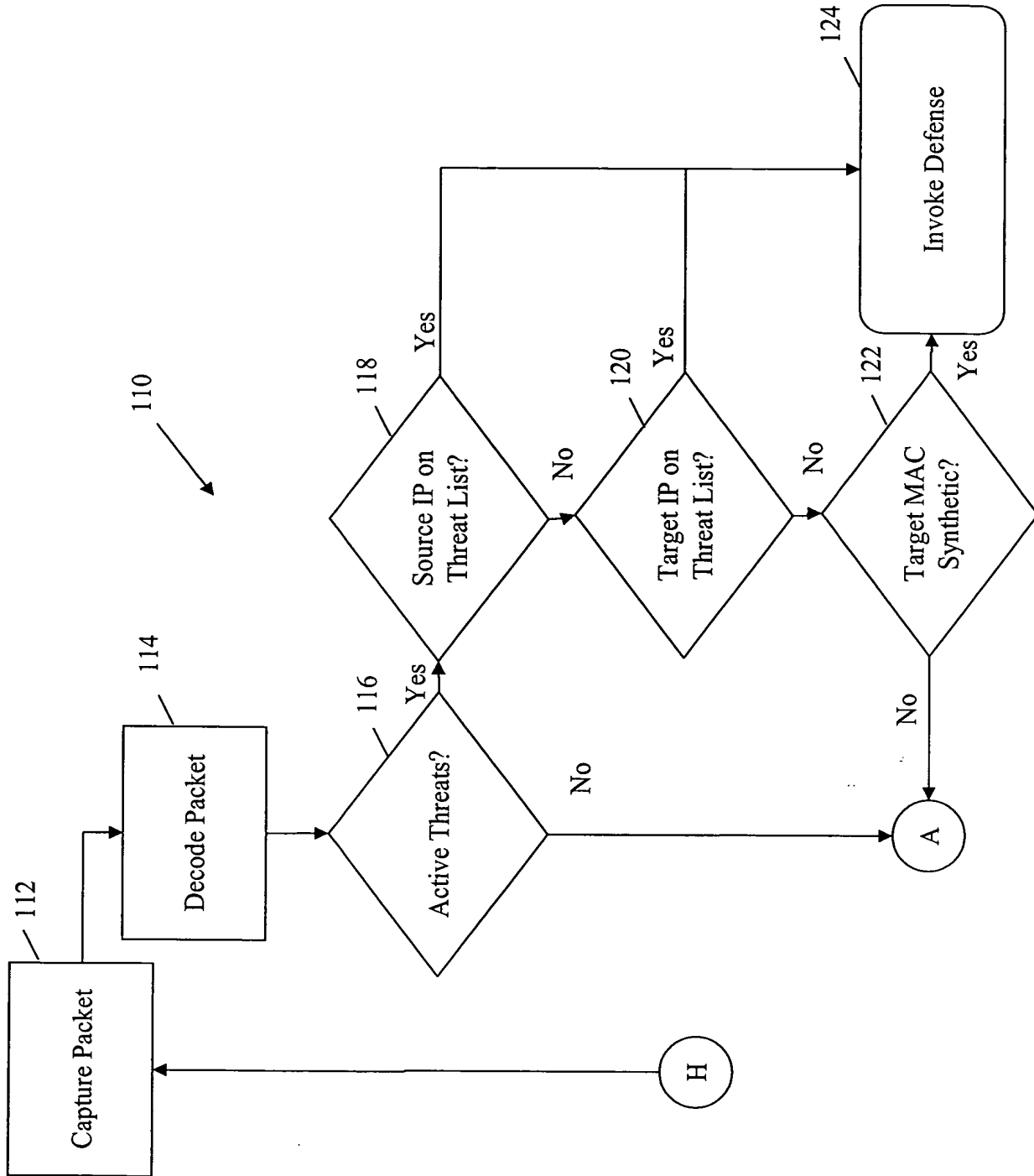

FIGURE 5

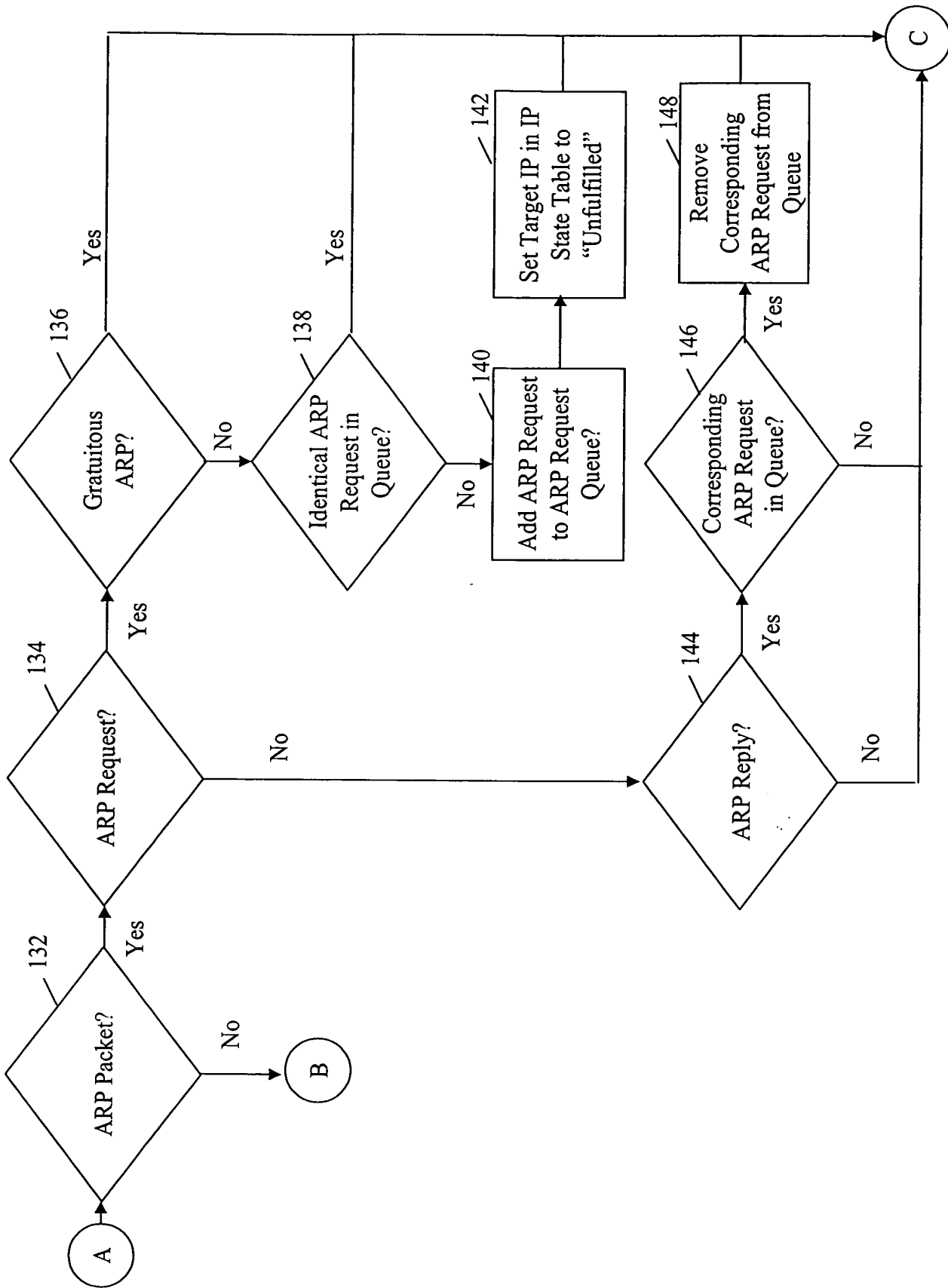

FIGURE 6

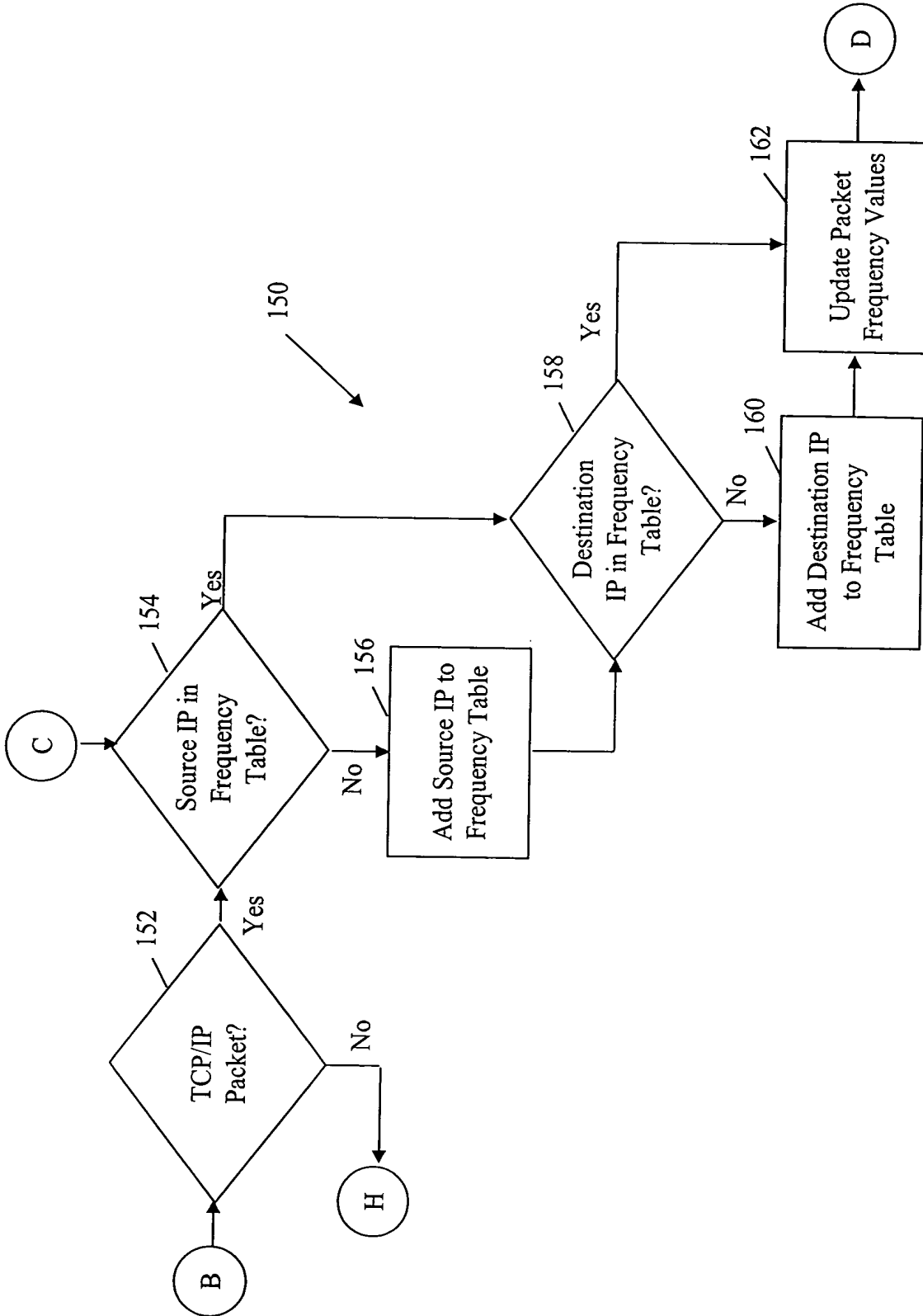

FIGURE 7

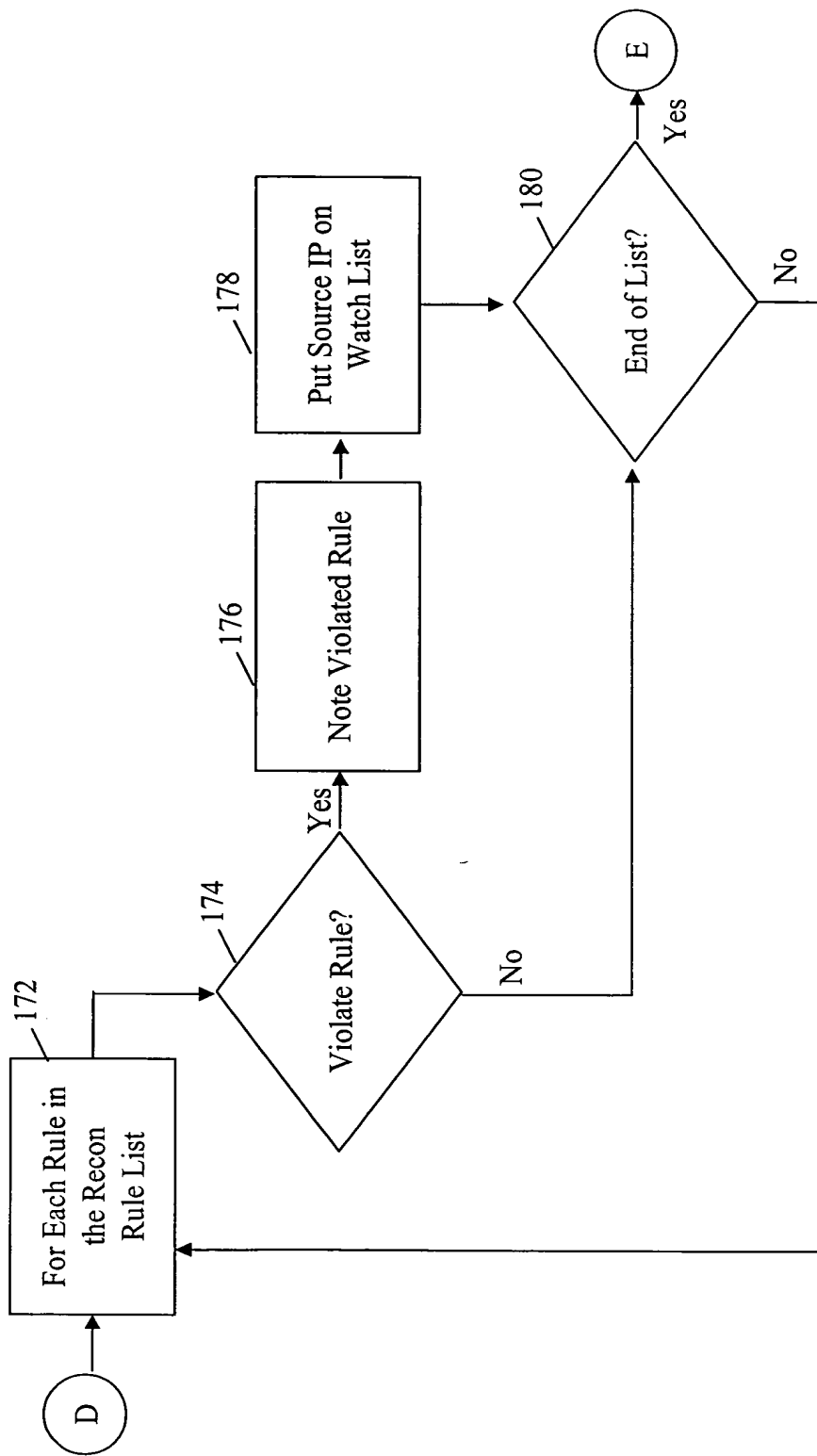

FIGURE 8

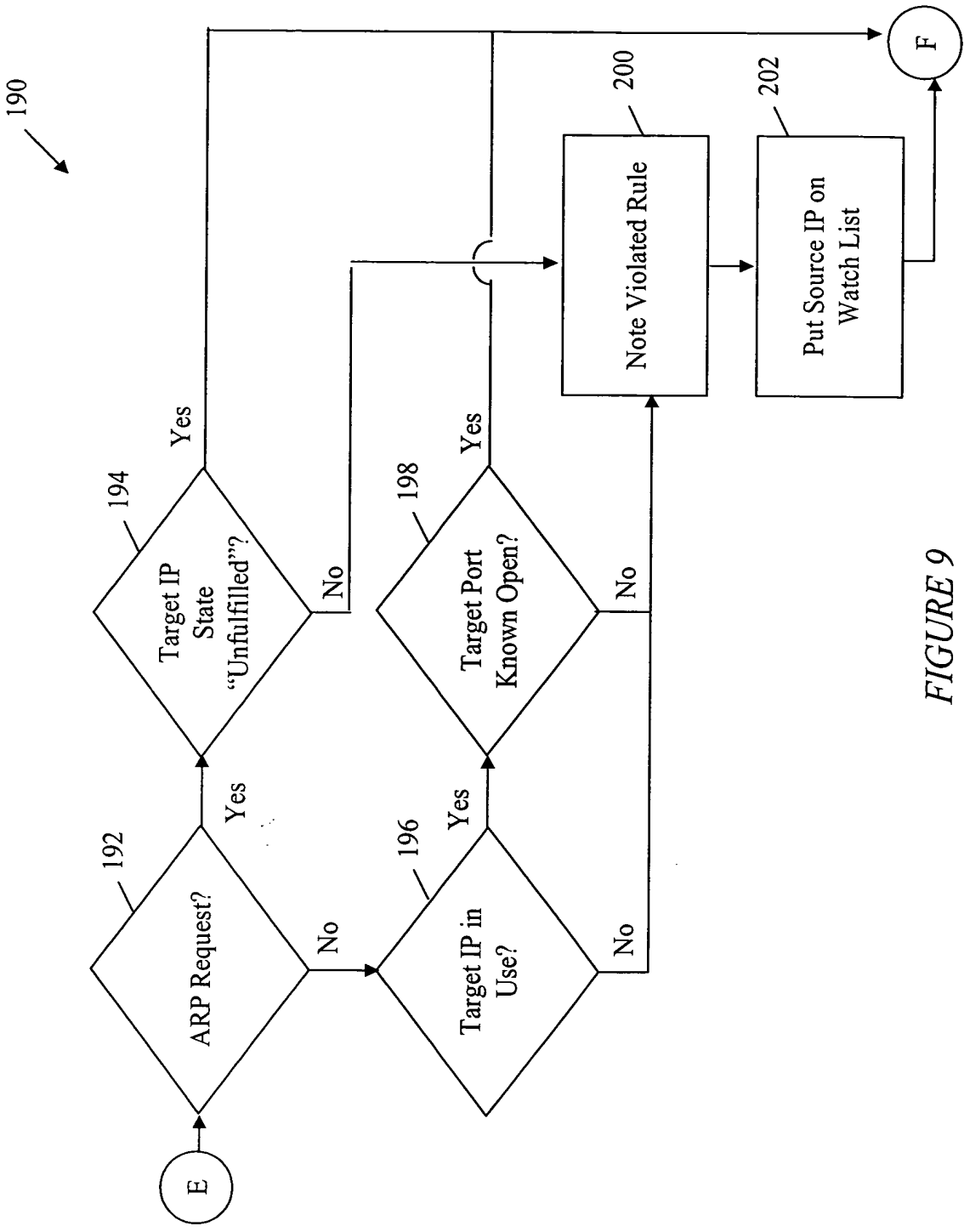

FIGURE 9

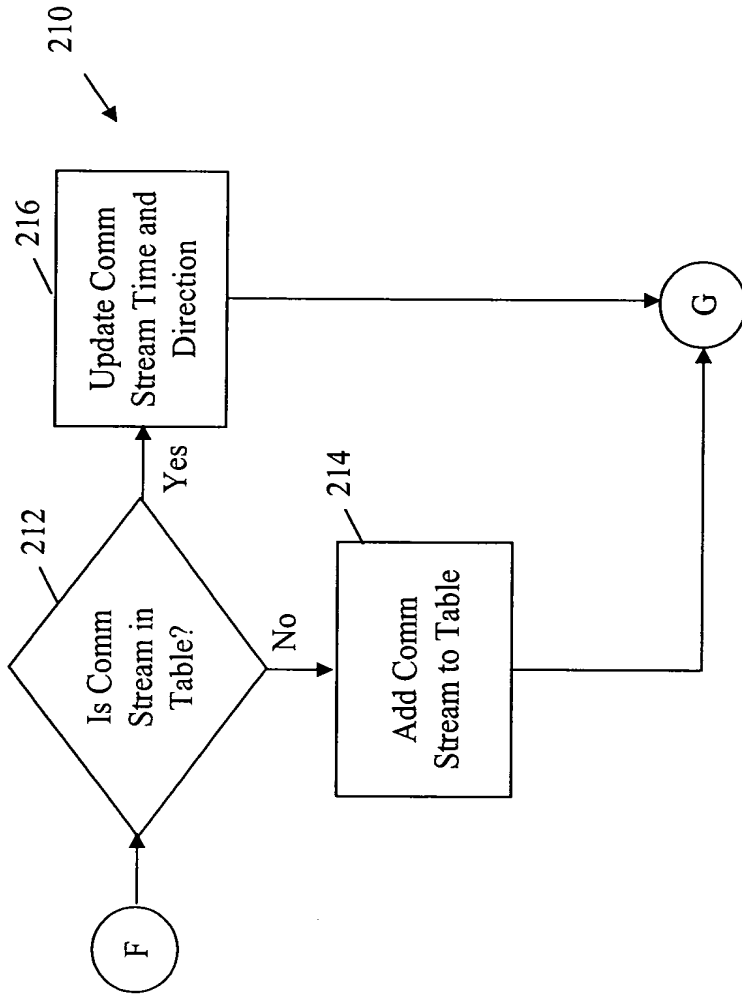

FIGURE 10

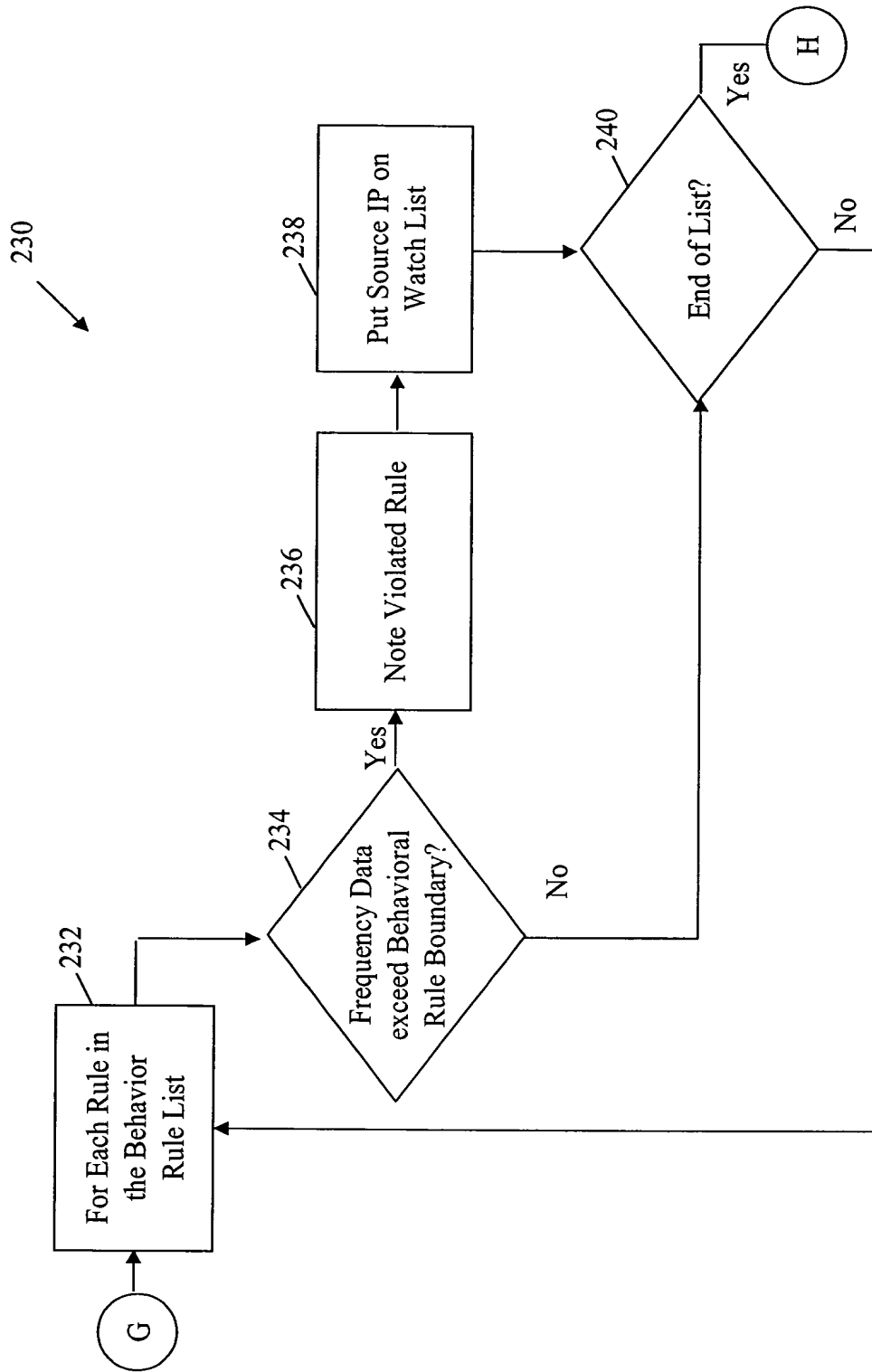

FIGURE 11

SIP	DIP	SMAC	TIME
183.76.0.7	192.82.0.1	00-08-21-C9-3e-C0	00:00:00.000

FIGURE 12

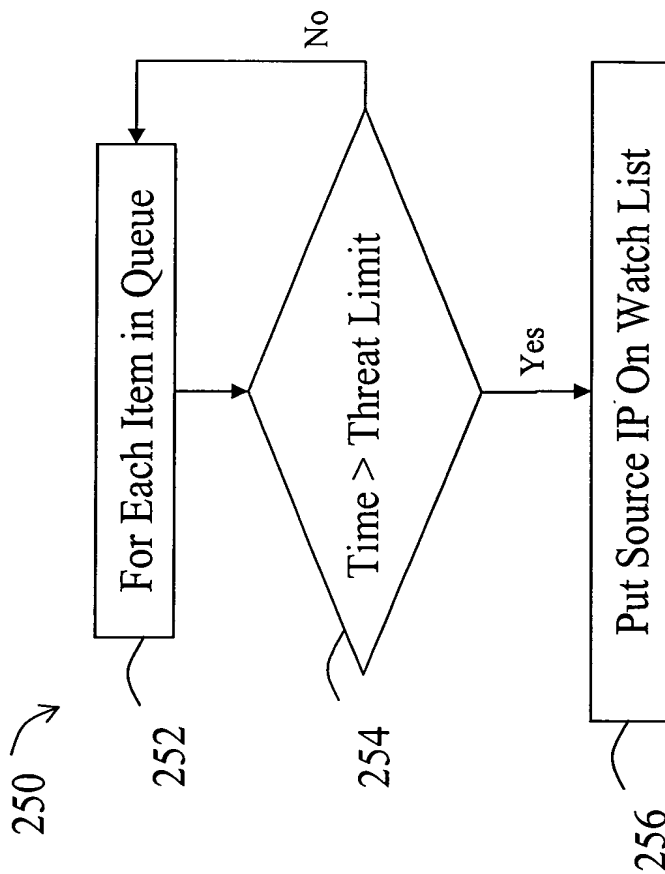

FIGURE 13

SIP	DIP	SMAC	TIME	RULE
183.76.0.7	192.82.0.1	00-08-21-C9-3e-C0	00:00:00.000	5

FIGURE 14

270 ↗

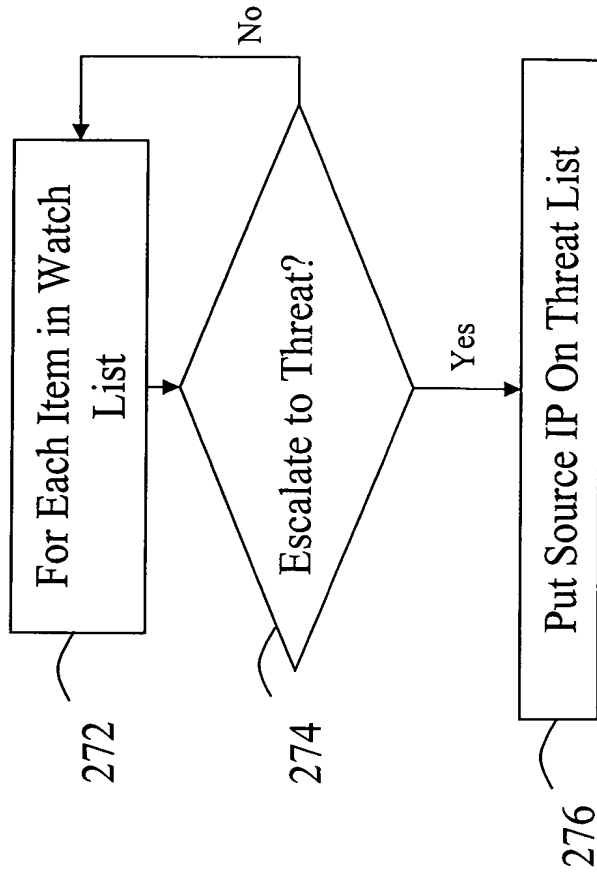

FIGURE 15

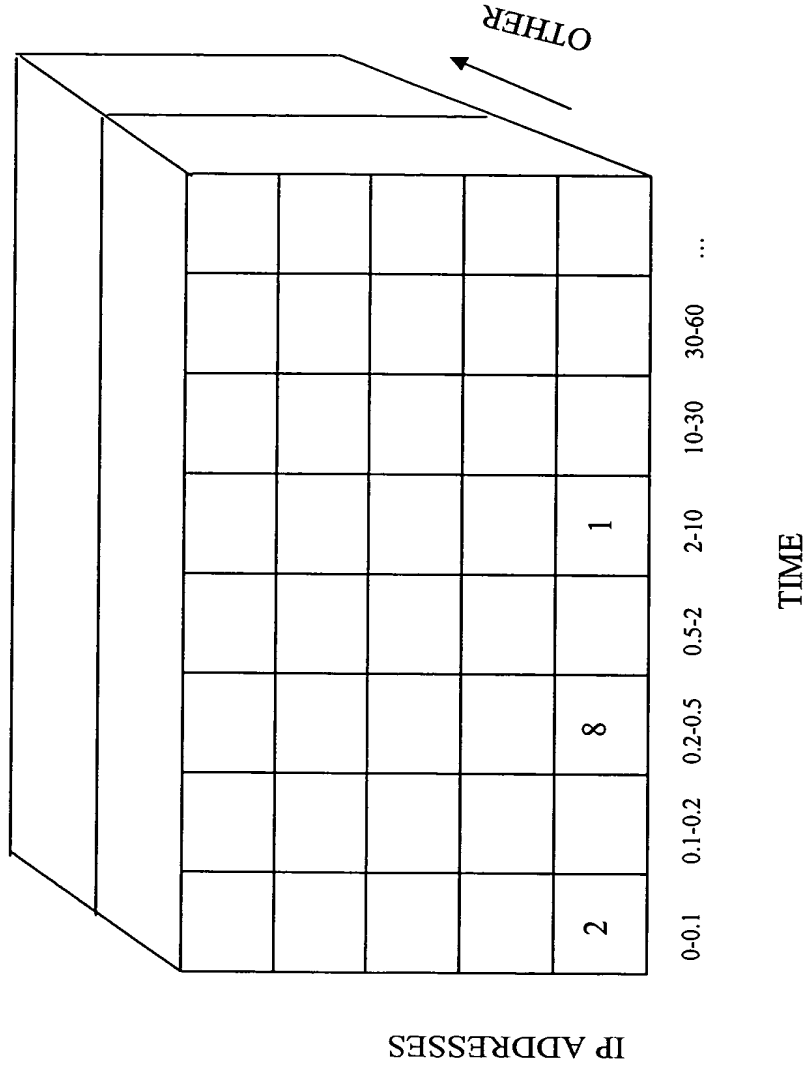

FIGURE 16

IP	STATE
192.82.0.1	1
192.82.0.2	4
183.76.0.7	3

FIGURE 17

DESTINATION

	USED	NOT USED
USED		
NOT USED		

SOURCE

FIGURE 18

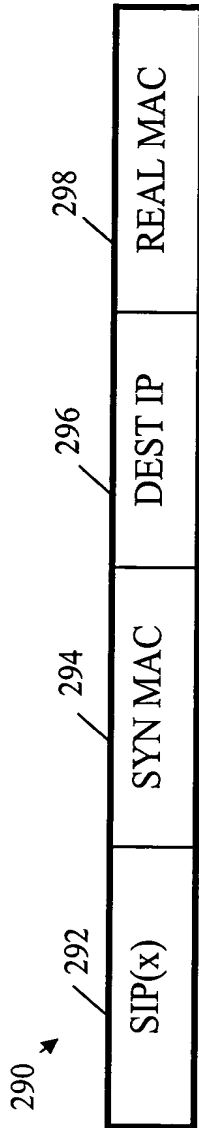

FIGURE 19

IP1	IP2	No.	Dir.	Time
183.76.0.7	192.82.0.1	10	1	00:00:00.000

FIGURE 20

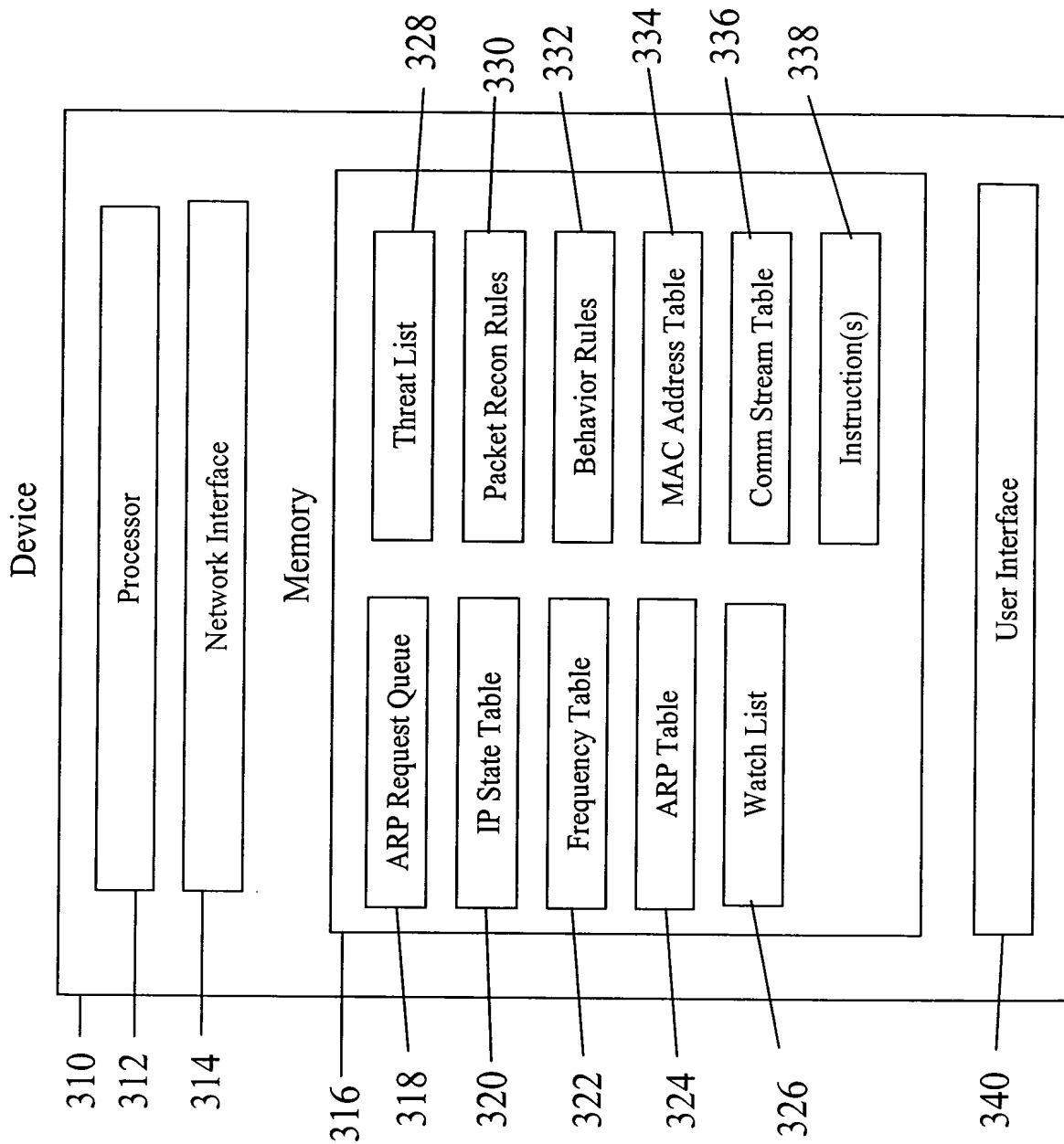

FIGURE 21

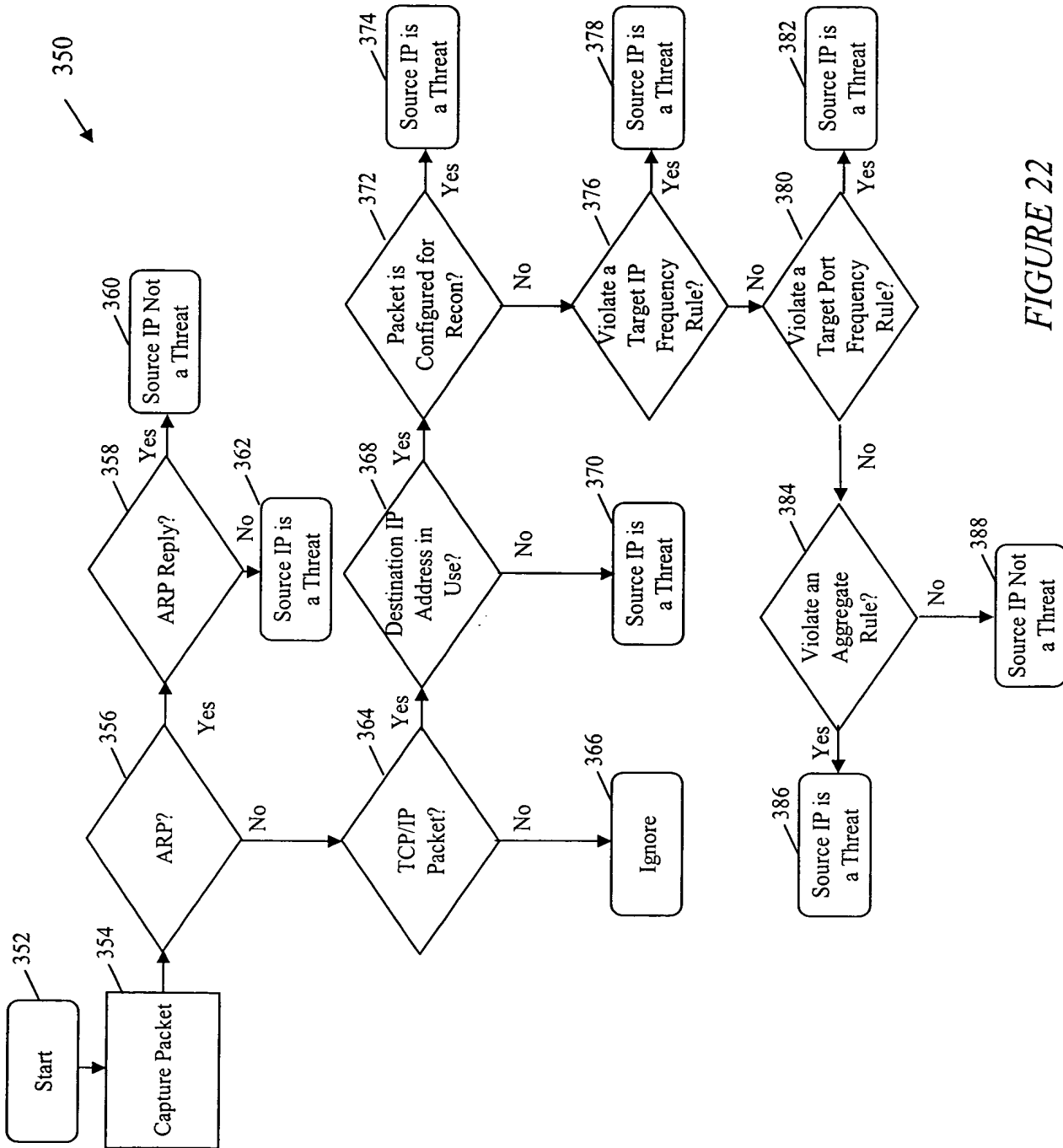

FIGURE 22

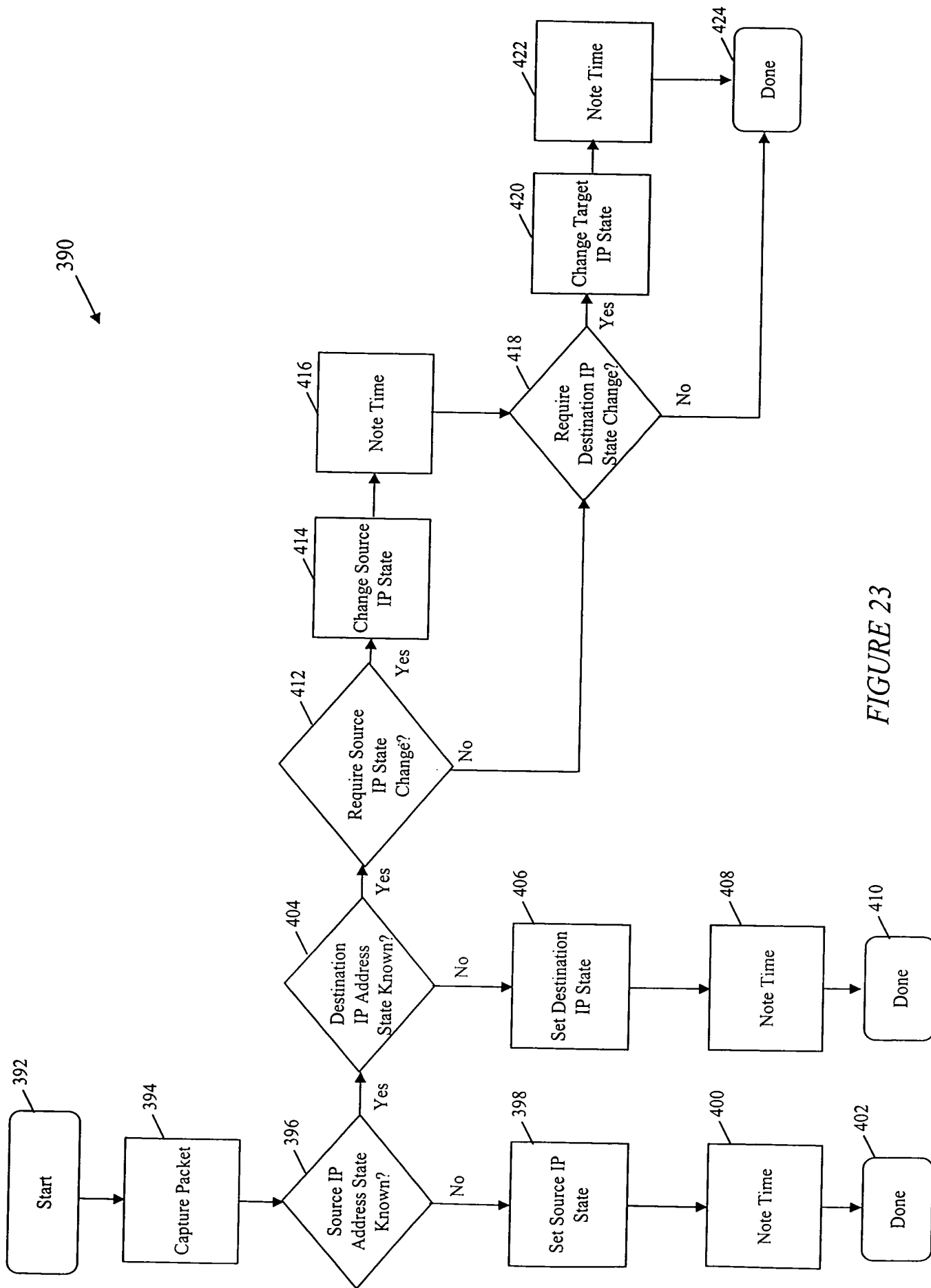

FIGURE 23

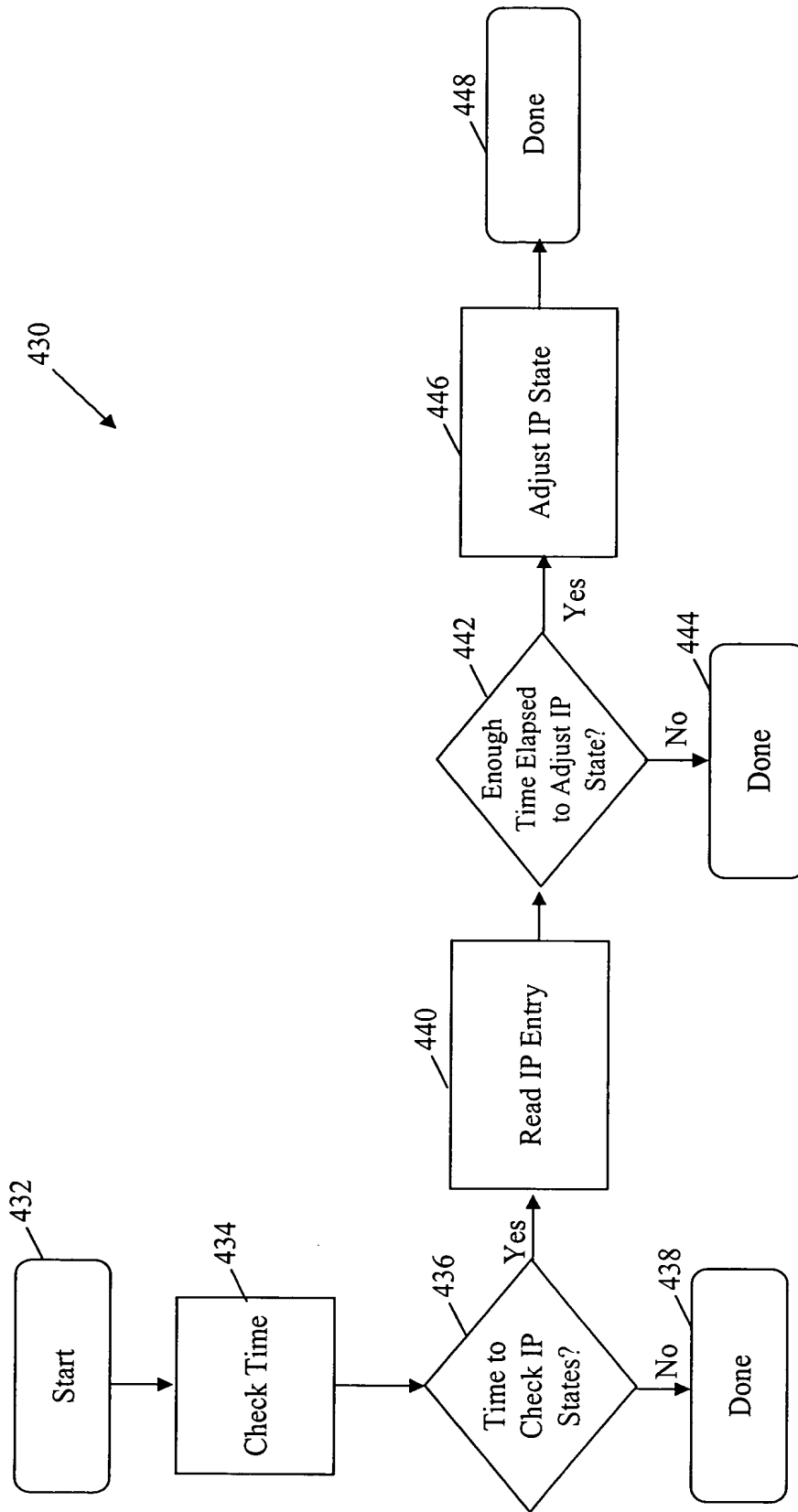

FIGURE 24

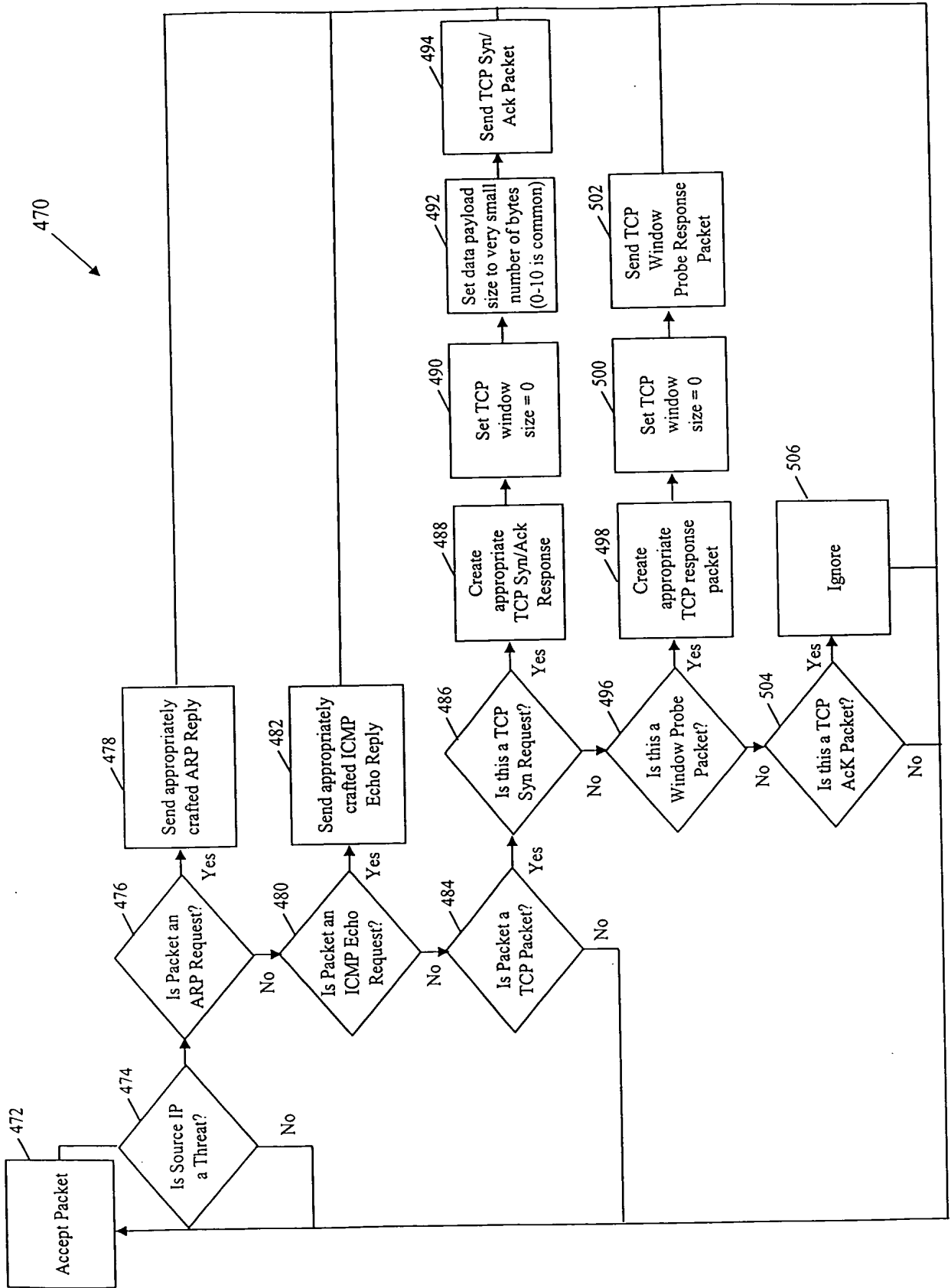

FIGURE 25

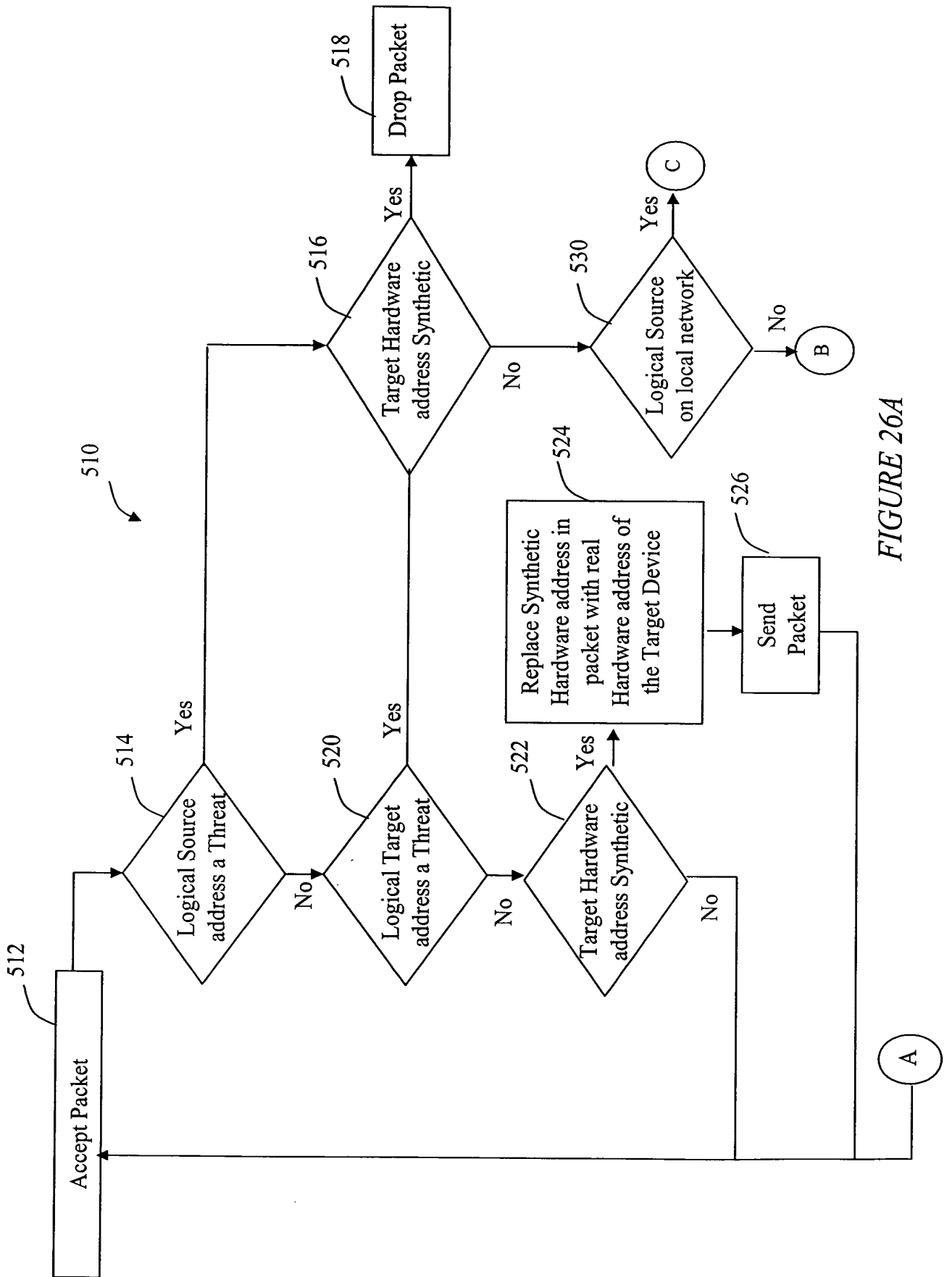

FIGURE 26A

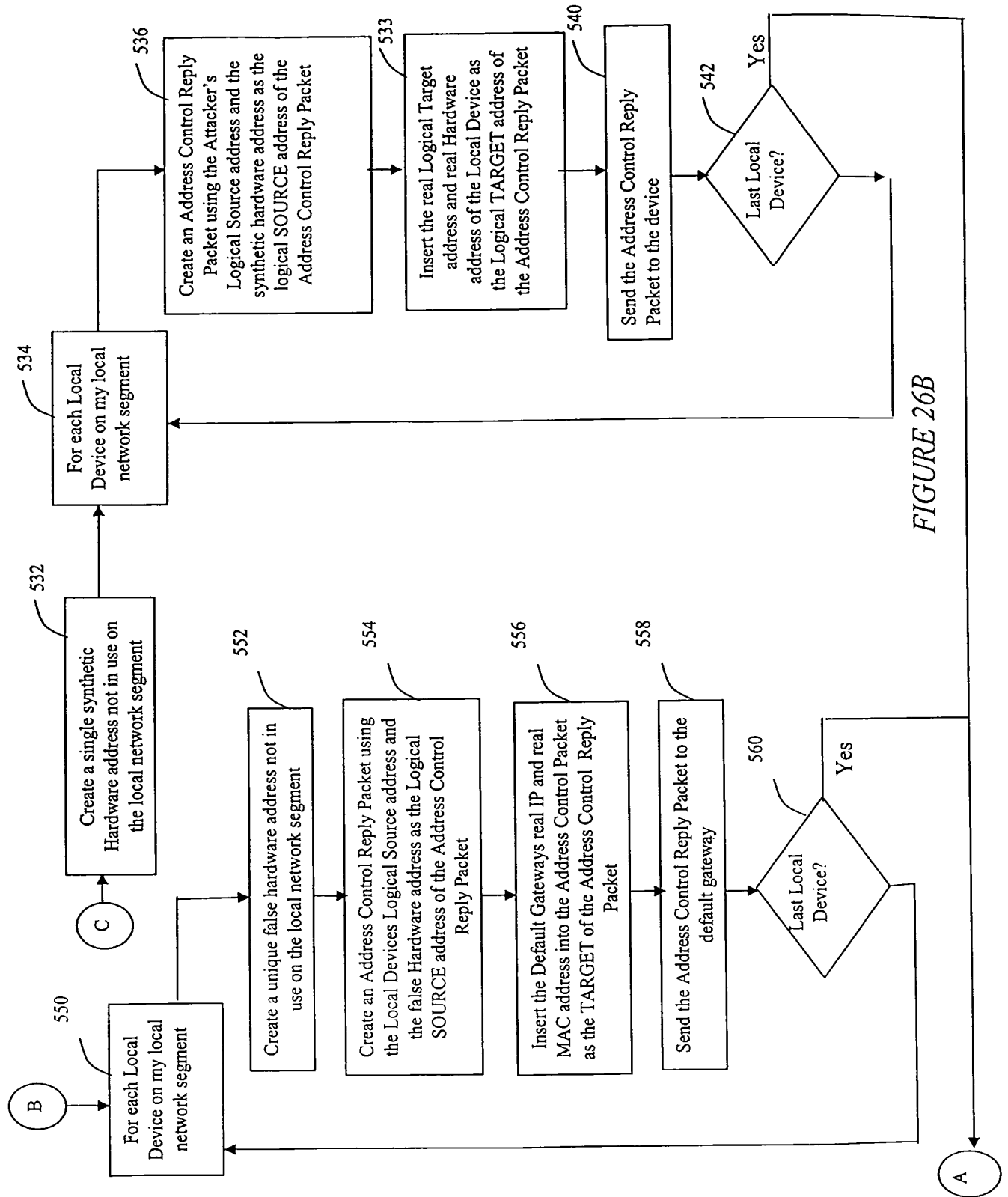

FIGURE 26B

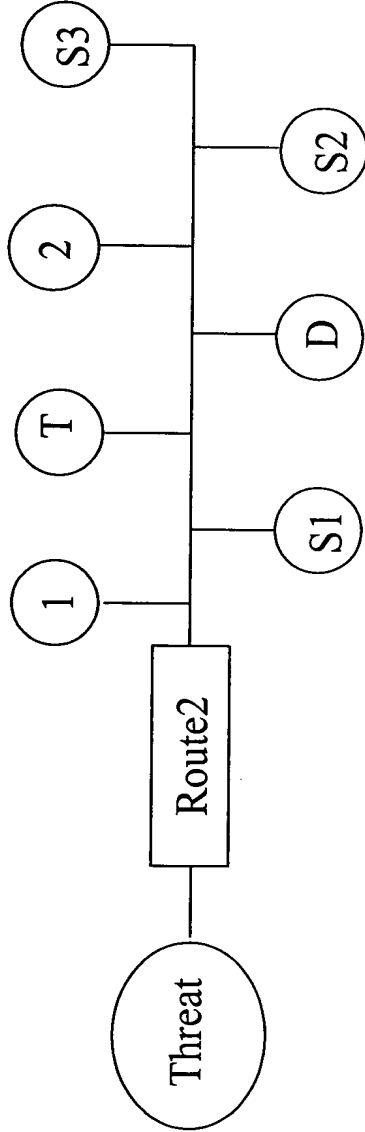

FIGURE 27